



# Instruction Sheet

102-067

## Timer and Aquastat

SUPERSEDES: November 15, 1992

EFFECTIVE: May 1, 2003

Plant ID# 001-979

### Application:

The Taco Clock Timer/Temperature Aquastat combination is designed to cycle the circulator during peak demand periods. The Analog Timer (No. 265-1) is adjustable to 15 minute intervals within a 24 hour time frame. The Digital Timer (No. 265-3) can be programmed for 7 day operation. The Temperature Aquastat (No. 563-2) automatically switches the circulator ON at 95°F and OFF at 115°F. The two can be used in combination, or they can be used separately. When the Clock Timer/Temperature Aquastat are used together, the Timer switches ON sending power to the unit. The Temperature Aquastat measures the temperature, and cycles the circulator as long as the Timer is switched to the ON mode.

If used separately, the Clock Timer operates the circulator during the chosen number of ON/OFF intervals. When using only the Temperature Aquastat, the circulator cycles intermittently to maintain a temperature between 95°F and 115°F.

The Clock Timer and Temperature Aquastat are easy to retrofit to any "00" Series Circulator. The user-friendly 24 hour analog clock has an hour hand, raised minute hand for ease of adjustment, two directional arrows, and AM/PM time settings. Our easy to program digital timer provides maximum convenience, comfort and energy savings. The Clock Timer can be mounted in any direction by just attaching it to the capacitor box electrical connection hole.

### Installation: FOLLOW ALL INSTRUCTIONS IN THE SEQUENCE THAT THEY APPEAR.

#### Analog Timer Installation Instructions:

1. Disconnect the electrical supply. Remove circulator terminal box screw and cover.
2. Loosen Timer box cover screw and remove cover.
3. Assemble the back portion of the Timer to the "00" terminal box as shown in the Timer installation diagram (006 circulator pictured). Make sure that the protruding tang on the back of the Timer box fits under the circulator's terminal box base. Adjust until the two terminal box openings are aligned.
4. Secure the locknuts. Feed the yellow and white circulator lead wires into the Timer through the bushing. Reassemble circulator terminal box cover and secure with the screw.
5. See electrical hook-up for Timer wiring.

#### Aquastat Installation Instructions:

1. Disconnect the electrical supply. Securely fasten the Aquastat clip to  $\frac{3}{4}$ " pipe or to the circulator casing for  $\frac{1}{2}$ " pipe applications. The Aquastat must be properly fastened to insure a good reading.
2. See electrical hook-up for Aquastat wiring.

### Electrical Hook-Up:

1. All electrical work must be performed by an electrician in accordance with the latest edition of the National Electrical Codes and Local Codes and Regulations.
2. Verify that the voltage, phase and frequency are correct for the Circulator, Timer and Aquastat prior to connection.
3. Follow the appropriate wiring diagram

### Analog Timer Programming:

1. Set the clock to the exact time of day using the clock face minute hand. Pay special attention to the corresponding AM and PM settings.
2. Supply power. Test circulator by pushing Timer lever into the manual position.
3. Set the desired ON/OFF times in 15 minute intervals. Push trippers away from clock face for ON operation, and leave trippers toward the clock face for OFF operation.

### Programming Modes:

1. Up = On, Constant circulation I
2. Middle = Automatic operation ⌚
3. Down = Off O

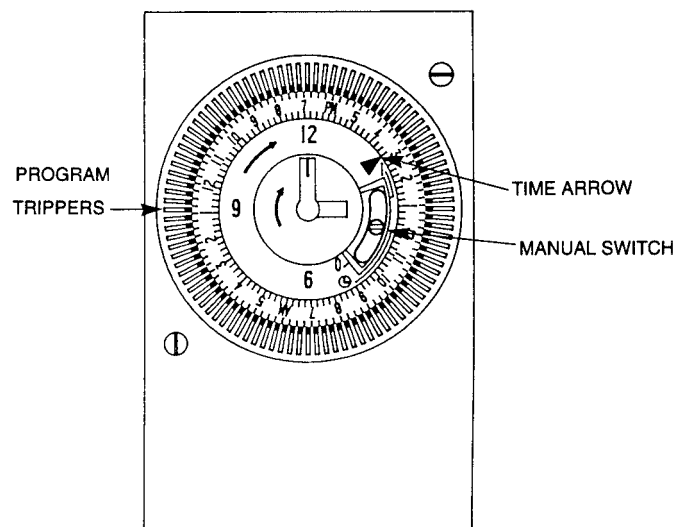

Analog Timer Clock Face

## Digital 7 Day Programmable Timer:

The Plumb n' Plug digital timer features a large LCD display and unique "circular programming" with large keys for easy setting and adjustments. A 100 hour capacitor backup retains program memory during power outages.

**Note:** Although the Plumb n' Plug digital timer contains some degree of spike and electrical noise protection, as with all electronic devices, these units can be affected by electrical noise. It is recommended that they be powered from a voltage source that has no switching devices or inductive loads connected.

### Digital Timer Technical Data:

Channels: 1  
 Programs: 20  
 Daylight time changeover: Manual  
 Manual 3-way override: On-Auto-Off  
 Shortest switching time: 1 minute  
 Reserve carryover: 100 hrs.  
 Input voltage: 120 VAC  
 Switching Output: SPDT relay  
 Switch ratings: 500 W @ 125 VAC  
 Input draw: 4 VA  
 Input frequency: 50 or 60 Hz  
 Wiring connections: 1/4" quick connect  
 Ambient temperature: -20°F to 140°F (-28°C to 60°C)  
 UL and Canadian UL recognized: File E83486

### Keypad Description:

- ⌚ Setting the Time/Automatic Run Mode
- Prog.** Program Mode
- Res.\*** Reset: Clears all programs and time
- ☞ Select ON or OFF in Prog. Mode, Manual Override in Run Mode
- ±1h\*** Manual Daylight Change Key
- h** Setting the Hour (12:-- AM)
- m** Setting the Minute (12:01 AM)
- Day** Set Day(s) for time and programs (Mon = 1, Tues = 2, . . . Sun = 7)

\* Recessed keys; use a pen point to press

### LCD Display Elements:

The LCD incorporates a number of different elements to display various data and information.

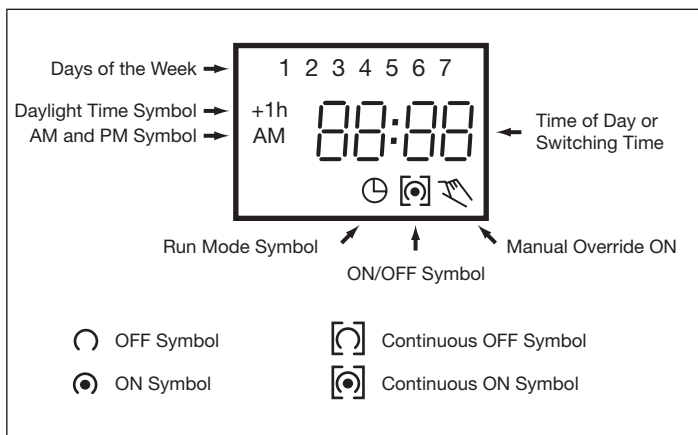

## Programs:

The PNP digital timer will accept up to 20 programs. A program consists of:

1. An ON or OFF command
2. Time of day (Hour and Minute)
3. Single day or multiple days

A program is required for each ON event, and a program is required for each OFF event.

**IMPORTANT:** BEFORE PROCEEDING WITH SETTING THE TIME AND PROGRAMMING THE UNIT, PRESS THE RESET KEY TO CLEAR ALL DATA FROM MEMORY.

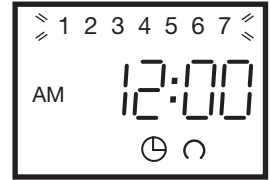

### Selecting AM/PM or Military Time:

After pressing reset, the display may show AM (right). The numbered day symbols will be flashing on and off.

If the display does not show AM, it is in military time mode (24:00 hr.). To change to AM/PM mode, press and hold the **h** key and press the **±1h** key once. AM will appear in display. If display is in AM mode and military mode is desired, press and hold the **h** key, press the **±1h** key once.

### Setting the Time:

**NOTE:** If the **h** and **m** keys are held down longer than 2 seconds, the numbers will advance rapidly.

Press and hold the ⌚ key during the following: (If Daylight Savings Time is in effect, press **±1h** first.)

1. Press **h** to advance to the current hour (while holding down the ⌚ key).
2. Press **m** to advance to the current minute (while holding down the ⌚ key).
3. Press **Day** repeatedly to advance to current day (while holding down the ⌚ key). (Mon = 1, Tues = 2, . . . Sun = 7)

**NOTE:** If the days are flashing, it indicates the day of the week was not set when setting the time. The timer cannot be programmed unless the day of the week is entered.

### Manual Daylight Time Changeover:

Each year, in the Spring, press **±1h** to advance the time an hour. In the Fall, press **±1h** to set back an hour.



Digital 7 Day Programmable Timer

## Programming 24 Hour or 7 Day Schedules:

Note: It is helpful to write out the program schedules *before* beginning. See last page.

**IMPORTANT:** THE CURRENT TIME OF DAY AND DAY OF WEEK MUST BE SET PRIOR TO PROGRAMMING. SEE "SETTING THE TIME".

### EXAMPLE (see back page)

**Program 1:** ON at 7:00 AM Monday thru Friday

**Program 2:** OFF at 8:00 AM Monday thru Friday

**Program 3:** ON at 8:00 AM Saturday and Sunday

**Program 4:** OFF at 9:00 AM Saturday and Sunday

Four programs need to be entered.

Press **Prog.** key only once. Display shows:

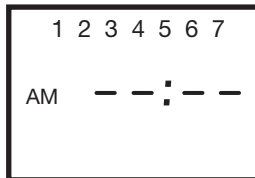

**Program 1:** ON at 7:00 AM Monday thru Friday

- Press  key once ON symbol (●) appears
- Press **h** key To 07 AM
- Press **m** key once To 00
- Press **Day** key 2 times 1 2 3 4 5 is displayed
- Press **Prog.** key to enter

**Program 2:** OFF at 8:00 AM Monday thru Friday

- Press  key twice OFF symbol (○) appears
- Press **h** key To 08 AM
- Press **m** key once To 00
- Press **Day** key 2 times 1 2 3 4 5 is displayed
- Press **Prog.** key to enter

**Program 3:** ON at 8:00 AM Saturday and Sunday

- Press  key once ON symbol (●) appears
- Press **h** key To 08 AM
- Press **m** key once To 00
- Press **Day** key 3 times until only 6 & 7 is displayed
- Press **Prog.** key to enter

**Program 4:** OFF at 9:00 AM Saturday and Sunday

- Press  key twice OFF symbol (○) appears
- Press **h** key To 09 AM
- Press **m** key once To 00
- Press **Day** key 3 times until only 6 & 7 is displayed
- Press **Prog.** key to enter

Program additional settings as desired (maximum of 10 ON/OFF programs). When all programs are complete, press  key to enter Run Mode.

**IMPORTANT:** IF AN "ON" TIME WAS PROGRAMMED THAT IS EARLIER IN THE DAY THAN THE CURRENT TIME, PRESS  ONCE TO TURN THE TIMER "ON". (IT DOES NOT "LOOK BACK" TO DETERMINE IF IT SHOULD BE ON OR OFF AFTER PROGRAMMING.)

**NOTE:** If 24 hour time control (same schedule every day of the week) is desired, ignore Day key.

If an ON or OFF symbol is not entered, the ON symbol will flash, and program will not be accepted.

## Day Key Selections:



Press Day Key	Display Shows	Days
0 times	1 2 3 4 5 6 7	Every Day
1 time	1 2 3 4 5 6	Mon - Sat
2 times	1 2 3 4 5	Mon - Fri
3 times	6 7	Sat & Sun
4 times	1	Monday
5 times	2	Tuesday
6 times	3	Wednesday
7 times	4	Thursday
8 times	5	Friday
9 times	6	Saturday
10 times	7	Sunday

## Reviewing Programs:





To review the programs at any time, press **Prog.** key. Programs will appear in the order they were entered with repeated presses of the **Prog.** key. After all programs have been reviewed, the blank display will appear to allow entering another program. Another press of the **Prog.** key will display the number of free programs available, such as **Fr 16** if 4 programs have been entered.

## Manual Override:

TEMPORARY: While in the Run Mode,

- Pressing the  key once will reverse the output; ON to OFF or OFF to ON. The  symbol appears in the display to indicate a temporary override. At the next scheduled switching time, automatic control resumes, eliminating the override.

CONTINUOUS: While in the Run Mode,

- Pressing the  key twice will turn the output to ON permanently. (●) symbol appears in display.
- Pressing the  key three times will turn the output OFF permanently. (○) symbol appears in display.
- To terminate a continuous override, press the  key until  appears in the display.

## Changing a Program:

Select the program to be changed with the **Prog.** key. A new set of days may be selected with the **Day** key just as in initial programming. Hour and minute can be changed with the **h** and **m** keys.

Press **Prog.** or  key to store the new program.

## Deleting a Program:

To delete only one or a few programs:

- Press **Prog.** key until the desired program is displayed.
- Press **m** key to **:59** and press once more to blank out.
- Press **h** key to **11PM** and press once more to blank out.
- Press  key, display will flash for several seconds and then enter the Run Mode.

Using the reset key will delete ALL programs, the time of day, and day of the week.

**Troubleshooting:**

**PROBLEM:** Days are flashing, pressing any key does nothing except key turns output On and OFF.

**SOLUTION:** **Time of Day** and **Day of Week** have not been set. See **“Setting the Time”**.

A second, but very unlikely cause of loss of program, is a power failure with the backup capacitor low or dead. Check by disconnecting power and monitoring how long the capacitor keeps the time of day in the display. Typically, the capacitor will maintain the time and programs for 4 days, but not more than 5 days.

**PROBLEM:** Time of day was set while holding the key down, but days are still flashing.

**SOLUTION:** Current day of week was not set **while holding down the key**. See **“Setting the Time”**.

**PROBLEM:** It is 10 AM and an ON program for 8 AM was entered, but the output is not ON. Display shows the and symbols.

**SOLUTION:** After programming, the timer does not “look back” to determine if it should be ON. Press the key (temporary override) to turn the output ON; appears in display. The timer will assume automatic operation at the next programmed event.

**PROBLEM:** A program for 8 AM Monday thru Friday was entered, but it will not accept it and is flashing.

**SOLUTION:** The ON or OFF was not entered as part of the program. On or OFF **must be selected**.

**PNP Digital Timer Program Schedules (Example)**

Program	ON/OFF	h	m	Day(s)
1	On	7 AM	00	Mon., Tue., Wed., Thurs., Fri.
2	Off	8 AM	00	Mon., Tue., Wed., Thurs., Fri.
3	On	8 AM	00	Saturday and Sunday
4	Off	9 AM	00	Saturday and Sunday

**Timer and Aquastat Wiring Diagram**

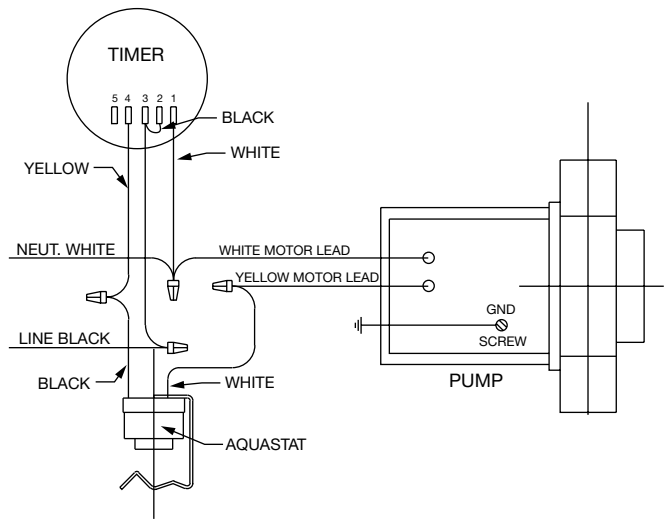

**Timer Only Wiring Diagram**

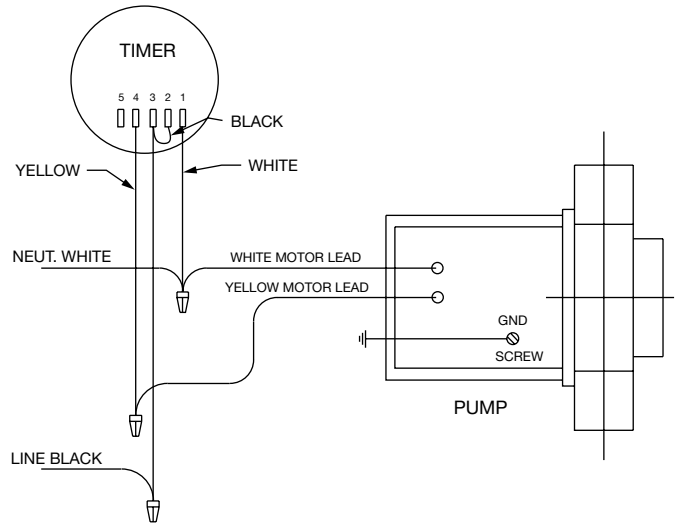

**Aquastat Only Wiring Diagram**

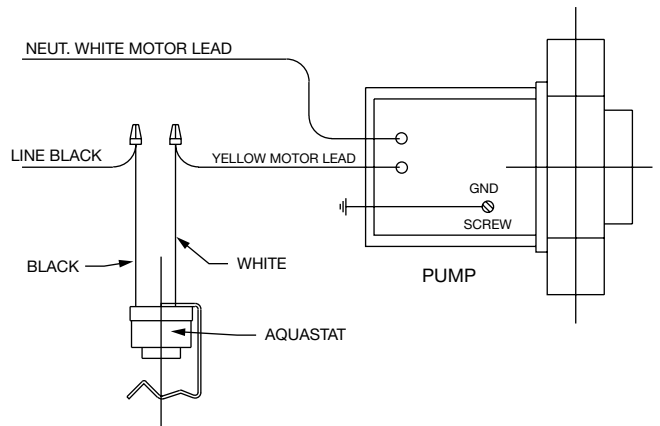

**Timer Installation Diagram (006 Circulator Shown)**

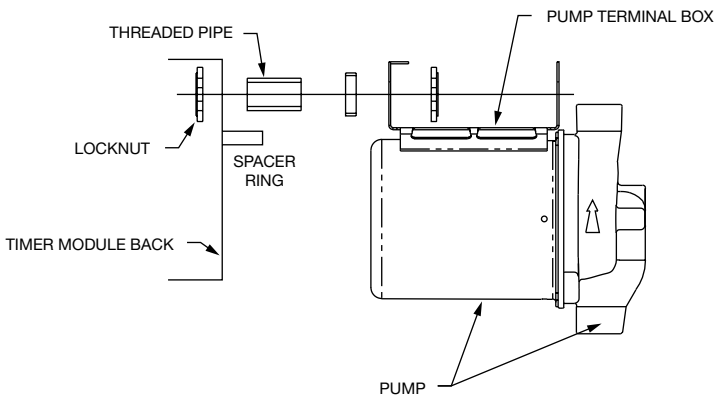

**DO IT ONCE. DO IT RIGHT.™**

TACO, INC., 1160 Cranston Street, Cranston, RI 02920 Telephone: (401) 942-8000 FAX: (401) 942-2360.

TACO (Canada), Ltd., 6180 Ordan Drive, Mississauga, Ontario L5T 2B3. Telephone: 905/564-9422. FAX: 905/564-9436.

Visit our web site at: <http://www.taco-hvac.com>

Printed in USA

Copyright 2003

TACO, Inc.